

PERI Rental Criteria 租賃準則

AB225

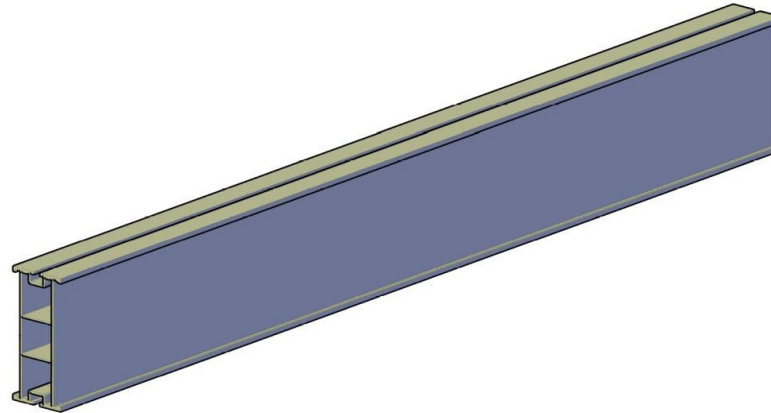

派利台灣有限公司
 台北市信義區基隆路一段163號
 10樓之一
 電話：02-3765-1211
 傳真：02-3765-1221
info@peri.tw

內容	頁數
AB 225	2
AB 225	2
AB 225 60.20.01.07 modification	7
AB 225 60.20.01.08 criteria added	8

修訂	日期 初始版本	頁數
New version 新版本	26.05.22 SR	
Version 3	13.05.24	
Version 4	19.12.24	
Version 5	02.03.26	

PERI Rental Criteria 租賃準則

AB225



AB225	描述	說明	收費說明	類型
	<p>60.20.01.01 Nail holes 釘孔</p> <ul style="list-style-type: none"> ▪ $d \leq 5 \text{ mm}$ ▪ $d > 5 \text{ mm}$ 	<p>    </p>	<p>   </p>	<p>   </p>
<p>60.20.01.02 Beam shortened 橫樑變短</p>		<p>   </p>	<p>  </p>	<p>  </p>

PERI Rental Criteria 租賃準則

AB225



AB225	描述	說明	收費說明	類型
-------	----	----	------	----



60.20.01.03 Beam bent 橫樑彎曲

- \leq permitted bent 少於容許彎曲
- $>$ permitted bent 大於容許彎曲



Component 構件	Perm. Bending 可接受的彎曲程度
AB225 1800	3 mm
AB225 2400	4 mm
AB225 2700	5 mm
AB225 3000	6 mm
AB225 3600	7 mm
AB225 4800	9 mm
AB225 5400	10 mm
AB225 5900	11 mm

PERI Rental Criteria 租賃準則

AB225











AB225	描述	說明	收費說明	類型
	<p>60.20.01.04 Soiled guide profile 溝槽內的泥土</p> <ul style="list-style-type: none"> ▪ if possible 如可以清除 			
	<ul style="list-style-type: none"> ▪ if not possible 如無法清除 			
	<p>60.20.01.04 Soiled guide either ends profile 任一端溝槽內的泥土</p> <ul style="list-style-type: none"> ▪ if possible 如可以清除 			
	<ul style="list-style-type: none"> ▪ if not possible 如無法清除 			

PERI Rental Criteria 租賃準則

AB225



AB225	描述	說明	收費說明	類型
	<p>60.20.01.05 Cracks at either end of inner profile 任一端內部結構已產生裂紋</p> <ul style="list-style-type: none"> Cracks 裂紋 L > 10mm 			
	<p>60.20.01.05 Cracks at either end of outer profile 任一端外部結構已產生裂紋</p> <ul style="list-style-type: none"> Cracks 裂紋 L > 10mm 			

PERI Rental Criteria 租賃準則

AB225











AB225	描述	說明	收費說明	類型
	<p>60.20.01.06 Cut in outer profile 外部結構已產生裂紋</p>			
	<p>60.20.01.06 Crack / Cut in outer profile 外部結構已產生裂紋</p>			

PERI Rental Criteria 租賃準則

AB225



AB225	描述	說明	收費說明	類型
	<p>60.20.01.07 Any deformation measure beyond from edge 10cm 從尾端測量10公分內結構輕微變形</p> <ul style="list-style-type: none"> ▪ Deformation 變位量 $\delta \leq 10\text{mm}$ 			
	<p>60.20.01.07 Any deformation measure beyond from edge 10cm 從尾端測量10公分內結構輕微變形</p> <ul style="list-style-type: none"> ▪ Deformation 變位量 $\delta > 10\text{mm}$ 			

PERI Rental Criteria 租賃準則

AB225



















AB225	描述	說明	收費說明	類型
	60.20.01.08 Any paint mark 任何油漆痕跡			

PERI Rental Criteria 租賃準則

Glossary Icons 圖示對照表



圖示	含意	圖示	含意	圖示	含意
	Not Ok– material is scrap 材料需報廢		Billing necessary (customer) 須收費		Optical damage 可見的損壞
	OK– material stays in rental park 材料仍在可租賃使用的範圍		No Billing necessary 無須收費		Functional damage 功能損壞
	Scrap material– it’s not permitted to hand out the material because of safety aspects 因安全考量無法再交付 · 材料需報廢		Shorten the material 需裁短/裁切		Functional damage— it’s not permitted to hand out the material 功能損壞 – 無法再使用
	Repair according to instruction 材料需依指示修復		Mark the material 需在材料上標記		Static damage— it’s not permitted to hand out the material 物理損壞 – 無法再使用
	Fix material cold—Afterwards check weld seams and bordering components 修復材料——之後檢查焊縫和邊界組件		Replace damaged material 需替換損壞材料		
	Clean the material 材料須清潔		Replace missing material 需替換遺失材料		

PERI Rental Criteria 租賃準則

PS100 Basic Components

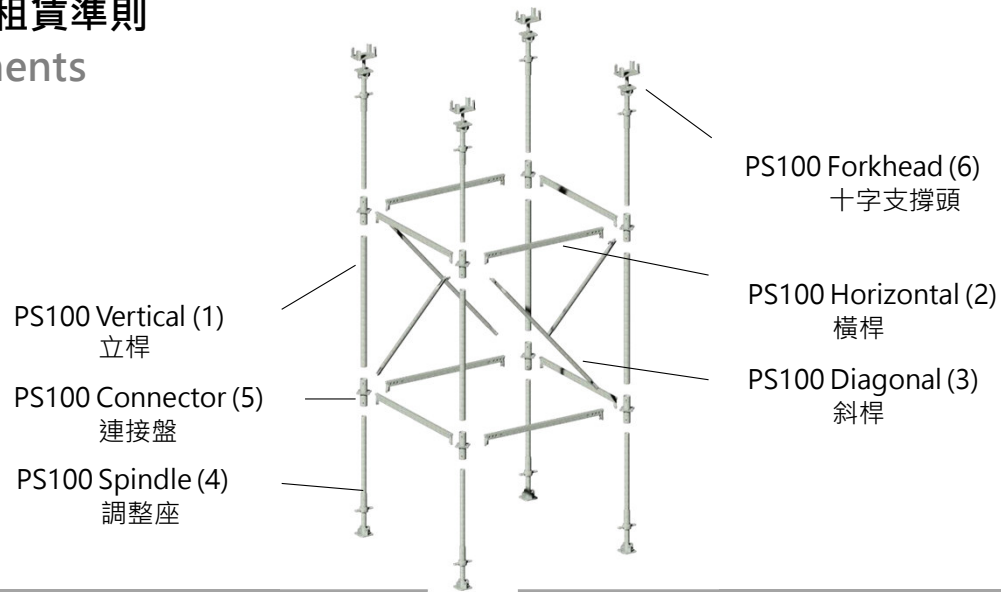

派利台灣有限公司
 台北市信義區基隆路一段163號
 10樓之一
 電話：02-3765-1211
 傳真：02-3765-1221
info@peri.tw

內容	頁數
PS100 Vertical 立桿	2
PS100 Horizontal 橫桿	3
PS100 Diagonal 斜桿	7
PS100 Spindle 調整座	10
PS100 Connector 連接盤	12
PS100 Forkhead 十字支撐頭	13
General instructions 通用準則	15

修訂	日期 初始版本	頁數
New version 新版本	17.05.22 SR	
New criteria added 新增準則	02.03.26	14

PERI Rental Criteria 租賃準則

PS100 Basic Components



PS100 Vertical 立桿	描述	說明	收費說明	類型
-------------------	----	----	------	----

60.10.01.1 PS100 Vertical bent > permitted bending (L/500) 立桿彎曲 > 可接受的彎曲程度

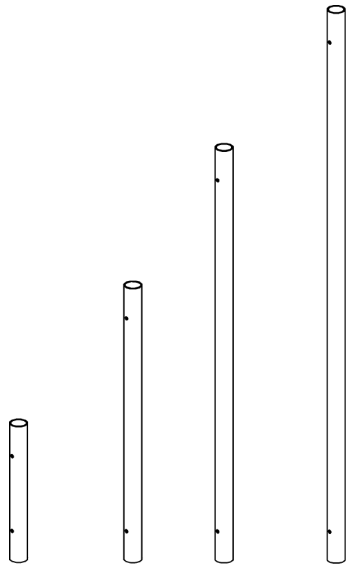

Component 構件	Perm. Bending 可接受的彎曲程度
PS100 VERTICAL 500	1 mm
PS100 VERTICAL 1000	2 mm
PS100 VERTICAL 1500	3 mm
PS100 VERTICAL 2000	4 mm

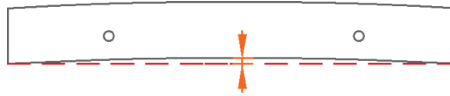

PERI Rental Criteria 租賃準則

PS100 Basic Components



PS100 Horizontal 橫桿	描述	說明	收費說明	類型
	<p>60.10.02.01 Local dent in profile 輪廓上的局部凹痕</p> <ul style="list-style-type: none"> Edges not affected 邊緣不受影響 			
	<p>60.10.02.02 Wedge-opening torn out Wedge missing 楔形開口破裂或遺失楔子</p>	 		

PERI Rental Criteria 租賃準則

PS100 Basic Components



















PS100 Horizontal 橫桿	描述	說明	收費說明	類型
	<p>60.10.02.03 Profile bent 型鋼彎曲</p>			
	<p>60.10.02.04 Dent in hook 鉤子凹陷</p> <ul style="list-style-type: none"> ▪ If possible 若可以修復 ▪ Or if not possible 若無法修復 ▪ Crack in material 材料裂開 	  	<p>088244</p>   	  

PERI Rental Criteria 租賃準則

PS100 Basic Components



PS100 Horizontal 橫桿	描述	說明	收費說明	類型
	<p>60.10.02.05 Hole dented 孔洞凹陷</p> <ul style="list-style-type: none"> If original geometry of the hole preserved 若保留原始的孔洞形狀 if changed 若孔洞形狀改變 Cracks in material 材料裂開 	<p>      </p>	<p>088244</p> <p>    </p>	<p>    </p>
	<p>60.10.02.06 Profile bent in vertical axis 型鋼在垂直軸上彎曲</p>	<p>   </p>	<p>  </p>	<p>  </p>

PERI Rental Criteria 租賃準則

PS100 Basic Components



PS100 Horizontal 橫桿	描述	說明	收費說明	類型
---------------------	----	----	------	----



60.10.02.07 Profile bent in horizontal axis 型鋼在水平軸上彎曲

- Edges not affected and
- \leq permitted bending ($l/300$ or 5 mm)
邊緣不受影響且橫桿彎曲程度在可接受範圍內

Component 構件	Perm. Bending 可接受的彎曲程度
PS100 Horizontal 250	1 mm
PS100 Horizontal 500	2 mm
PS100 Horizontal 750	2 mm
PS100 Horizontal 1000	3 mm
PS100 Horizontal 1500	5 mm
PS100 Horizontal 2000	5 mm
PS100 Horizontal 2500	5 mm
PS100 Horizontal 3000	5 mm

- $>$ permitted bending



PERI Rental Criteria 租賃準則

PS100 Basic Components



PS100 Diagonal 斜桿	描述	說明	收費說明	類型
	<p>60.10.03.01 Wedge or fork bolt damaged missing 楔子或叉栓損壞或遺失</p>			
	<p>60.10.03.02 Dents in profile 型鋼上的凹痕</p> <ul style="list-style-type: none"> ▪ d > 3 cm 			

PERI Rental Criteria 租賃準則

PS100 Basic Components



PS100 Diagonal 斜桿	描述	說明	收費說明	類型
-------------------	----	----	------	----



60.10.03.03 Profile bent 型鋼彎曲

- > permitted bending 5 mm (l/500)

Component 構件	Perm. Bending 可接受的彎曲程度
PS100 Diagonal 1000/500	2 mm
PS100 Diagonal 1000/1000	3 mm
PS100 Diagonal 1000/1500	3 mm
PS100 Diagonal 1000/2000	4 mm
PS100 Diagonal 1500/500	3 mm
PS100 Diagonal 1500/1000	3 mm
PS100 Diagonal 1500/1500	4 mm
PS100 Diagonal 1500/2000	5 mm
PS100 Diagonal 2000/500	4 mm
PS100 Diagonal 2000/1000	4 mm
PS100 Diagonal 2000/1500	5 mm
PS100 Diagonal 2000/2000	5 mm
PS100 Diagonal 2500/1000	5 mm
PS100 Diagonal 2500/1500	5 mm
PS100 Diagonal 2500/2000	5 mm



PERI Rental Criteria 租賃準則

PS100 Basic Components



PS100 Spindle 調整座	描述	說明	收費說明	類型
	<p>60.10.04.01 Spindle bent 調整座彎曲</p>			
	<p>60.10.04.02 Thread 螺紋</p> <ul style="list-style-type: none"> ▪ Heavily soiled 嚴重汙損 ▪ Damaged (nut not moveable) 損壞 (螺母無法轉動) 	 	 	 

PERI Rental Criteria 租賃準則

PS100 Basic Components



PS100 Spindle 調整座	描述	說明	收費說明	類型
-------------------	----	----	------	----



60.10.04.03 Nut broken 螺母損壞



60.10.04.04 Base plate bent 底板彎曲

- Bent (spindle not affected)
底板彎曲但軸心不影響
- Bent and spindle affected
底板彎曲且軸心受影響
- Weld cracked 焊接處裂開







088244

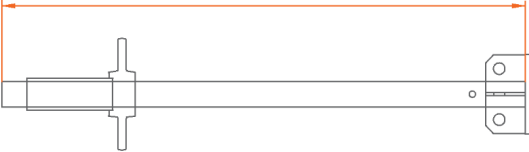

PERI Rental Criteria 租賃準則

PS100 Basic Components



PS100 Spindle 調整座	描述	說明	收費說明	類型
	60.10.04.05 Spindle cut off 調整座被切斷	 		

PERI Rental Criteria 租賃準則

PS100 Basic Components



PS100 Connector 連接盤	描述	說明	收費說明	類型
---------------------	----	----	------	----

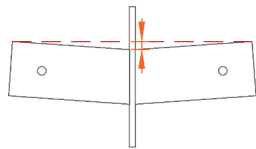

60.10.05.01 Tube squeezed or bent
連接管被擠壓或彎曲



60.10.05.02 Rosett bent 連接盤彎曲

- <10 mm
- >10 mm
- Cracks in the rosette 連接盤裂開

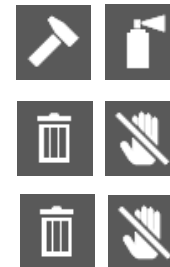

















088244



PERI Rental Criteria 租賃準則

PS100 Basic Components



PS100 Forkhead 十字支撐頭	描述	說明	收費說明	類型
	<p>60.10.06.01 Base plate bent 底板彎曲</p> <ul style="list-style-type: none"> > 5 mm 	 		
	<p>60.10.06.02 Angles bent 十字支撐頭彎曲</p> <ul style="list-style-type: none"> Bent without crack in welding 焊接彎曲無裂紋 Bent with crack in welding 焊接彎曲有裂紋 Missing 遺失 	    	<p>088244</p>   	  

PERI Rental Criteria 租賃準則

PS100 Basic Components



















General Instructions 通用準則	描述	說明	收費說明	類型
	<p>60.10.07.01 Heavily soiled 嚴重汙損</p>			
	<p>60.10.07.01 Any paint mark 任何油漆痕跡</p>			

PERI Rental Criteria 租賃準則

Glossary Icons 圖示對照表



圖示	含意	圖示	含意	圖示	含意
	Not Ok– material is scrap 材料需報廢		Billing necessary (customer) 須收費		Optical damage 可見的損壞
	OK– material stays in rental park 材料仍在可租賃使用的範圍		No Billing necessary 無須收費		Functional damage 功能損壞
	Scrap material– it’s not permitted to hand out the material because of safety aspects 因安全考量無法再交付 · 材料需報廢		Shorten the material 需材短材料		Functional damage— it’s not permitted to hand out the material 功能損壞 – 無法再使用
	Repair according to instruction 材料需依指示修復		Mark the material 需在材料上標記		Static damage— it’s not permitted to hand out the material 物理損壞 – 無法再使用
	Fix material cold—Afterwards check weld seams and bordering components 修復材料——之後檢查焊縫和邊界組件		Replace damaged material 需替換損壞材料		
	Clean the material 材料須清理		Replace missing material 需替換遺失材料		

PERI Rental Criteria 租賃準則

VARIO Accessories



派利台灣有限公司
 台北市信義區基隆路一段
 163號10樓之一
 電話：02-3765-1211
 傳真：02-3765-1221
info@peri.tw

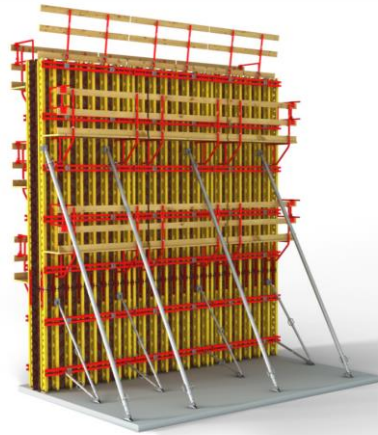

內容	頁數	修訂	日期 初始版本	頁數
Hook Straps 吊鉤帶	2	New version 新版本	01/2018 fw	
Crane Hook-2 吊鉤-2	17			
Tie Yoke Head SRU 背撐頭 SRU	20			
Various Accessories 各式配件	22			
Glossary Icons 圖示對照表	32			

PERI Rental Criteria 租賃準則

VARIO Accessories



Hook Strap 吊鉤帶 24-100/120 | 24-140/160

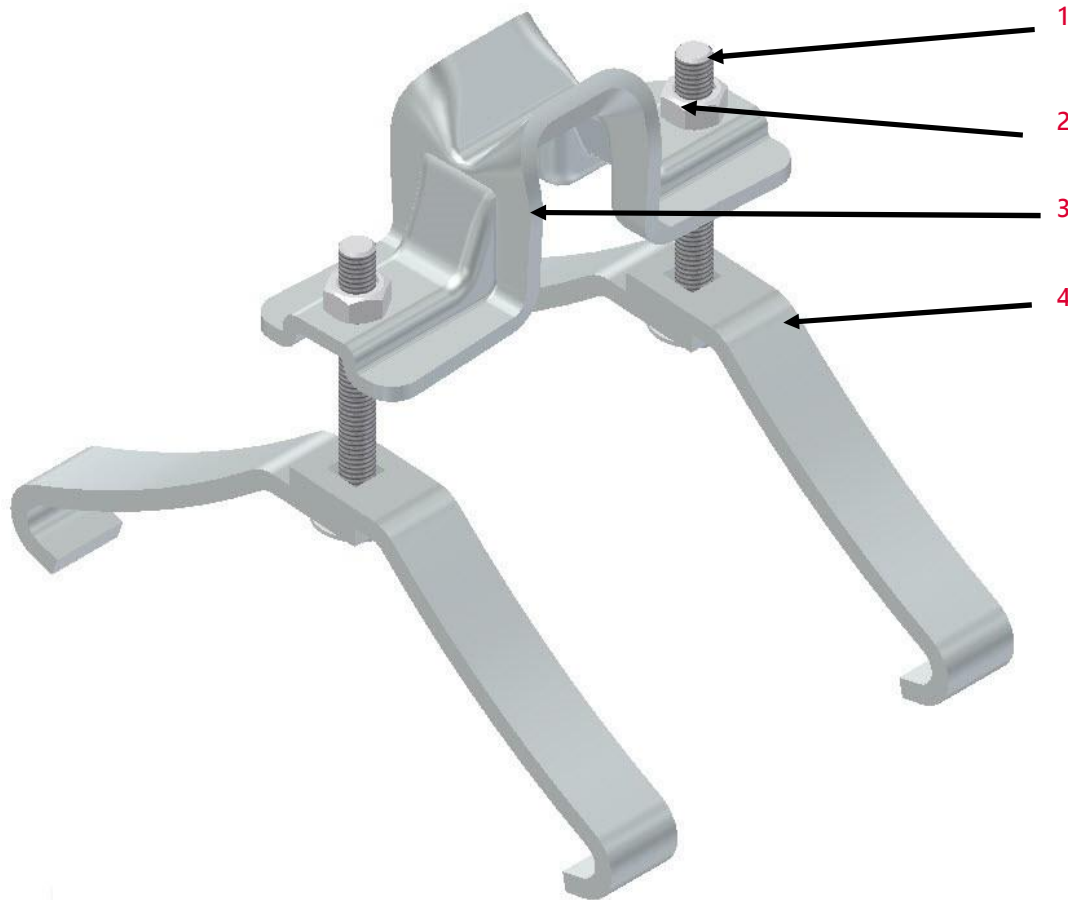

















No.	Name 名稱	Article number 品項編號
1	Bolt 螺栓	126228
2	Nut 螺帽	024090
3	Horizontal bracket 水平支架	710253
4	Tension bracket 24-100/120 拉力支架 24-100/120	024040
4	Tension bracket 24-140/160 拉力支架 24-140/160	722690

Valid for 適用產品	Article number 品項編號
Hook Strap 24-100/120	024070
Hook Strap 24-140/160	

PERI Rental Criteria 租賃準則

VARIO Accessories



Hook Strap 吊鉤帶 24-100/120 24-140/160	描述	說明	收費說明	類型
	09.01 Bolt Nut 螺栓 螺帽			
	■ Missing 遺失			
	■ Or bent 或彎曲			
	09.02 Tension bracket 拉力支架			
	■ Missing 遺失			
	■ Or bent 或彎曲			

PERI Rental Criteria 租賃準則

VARIO Accessories



Hook Strap 吊鉤帶 24-100/120 24-140/160	描述	說明	收費說明	類型	
	09.03 Rusty 生鏽	<ul style="list-style-type: none"> ■ Degree of rust A; B or C 生鏽程度 A、B或C 			
	<ul style="list-style-type: none"> ■ Degree of rust > C 生鏽程度 > C 				
	09.04 Soiled heavily 嚴重汙損	<ul style="list-style-type: none"> ■ If removable 如可清除 			
	<ul style="list-style-type: none"> ■ Or if not and parts replaceable 或如不可清除，而零件可替換 				
	<ul style="list-style-type: none"> ■ Or if parts not replaceable 或如零件無法替換 				

PERI Rental Criteria 租賃準則

VARIO Accessories



Hook Strap Uni HBU, 吊鉤帶 HBU

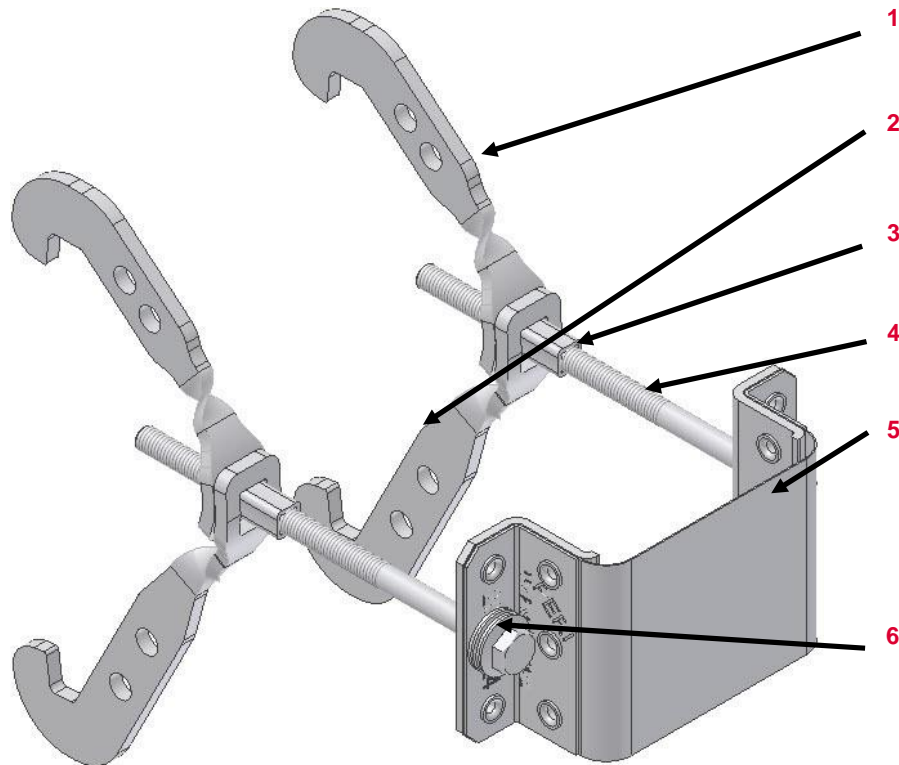

No.	Name 名稱	Article number 品項編號
1	Hook 123 鉤子 123	103840
2	Hook 160 鉤子 160	103842
3	Sleeve 套管	103844
4	Bolt 螺栓	
5	Strap 金屬帶	
6	Disk spring 墊圈	109870

Valid for 適用產品	Article number 品項編號
Hook Strap Universal HBU 24-28	103845
Hook Strap Universal HBU 20-24	104931
Hook Strap Universal HBU 16-26 U200	111806
Hook Strap Universal Double 24-28	104096
Hook Strap Universal Double 20-24	104930
Hook Strap MPB 24/GT24	111000

Hook Strap Uni HBU, 吊鉤帶 HBU	描述	說明	收費說明	類型
	<p>09.05 Complete Hook strap soiled with concrete 整支吊鉤帶都沾滿混凝土</p>			
	<p>09.06 Bolt soiled with concrete 螺栓沾滿混凝土</p>			

PERI Rental Criteria 租賃準則

VARIO Accessories



Hook Strap Uni HBU, 吊鉤帶 HBU	描述	說明	收費說明	類型
	<p>09.07 Strap soiled with concrete 金屬帶沾滿混凝土</p> <ul style="list-style-type: none"> ■ Screws can be tighten 螺絲可以被鎖緊 ■ Or soiled heavily 或嚴重汙損 	<p>✓</p> <p>⚙️</p>	<p>🚫</p> <p>🔧</p>	<p>👁️</p> <p>⚙️</p>
	<p>09.08 Strap bent 金屬帶彎曲</p>	<p>⚙️</p>	<p>🔧</p>	<p>⚙️</p>

















Hook Strap Uni HBU, 吊鉤帶 HBU	描述	說明	收費說明	類型
	<p>09.09 Bolt bent 螺栓彎曲</p>			
	<p>09.10 Rust 生鏽</p> <ul style="list-style-type: none"> ■ At the bolts (bolts not movable) 在螺栓上 (螺栓無法移動) ■ Degree of rust until class C 在生鏽程度 C 以下 ■ Degree of rust D 生鏽程度 D 	 	 	

Hook Strap Uni HBU, 吊鉤帶 HBU	描述	說明	收費說明	類型
	09.11 Strap bent 金屬帶彎曲			
	<ul style="list-style-type: none"> <li data-bbox="853 560 1285 592">■ Smooth bent 可撫平的彎曲 <li data-bbox="853 703 1285 735">■ Or kink 或扭結 			
	09.12 Crack in strap 金屬帶破裂			

PERI Rental Criteria 租賃準則

VARIO Accessories



Hook Strap Uni HBU, 吊鉤帶 HBU	描述	說明	收費說明	類型
	09.13 Nail holes 釘孔			
	<ul style="list-style-type: none"> ■ ≤25 % material loss ≤25 % 材料損失 			
	<ul style="list-style-type: none"> ■ Or > 25 % material loss 或 > 25 % 材料損失 			
<ul style="list-style-type: none"> ■ Or holes > Ø 5 mm 或孔洞 > Ø 5 mm 				
	09.14 Dent in strap 金屬帶凹痕			
	<ul style="list-style-type: none"> ■ ≤Ø 2 cm 			
<ul style="list-style-type: none"> ■ Or > Ø 2 cm 				

Hook Strap HB, 吊鉤帶 HB

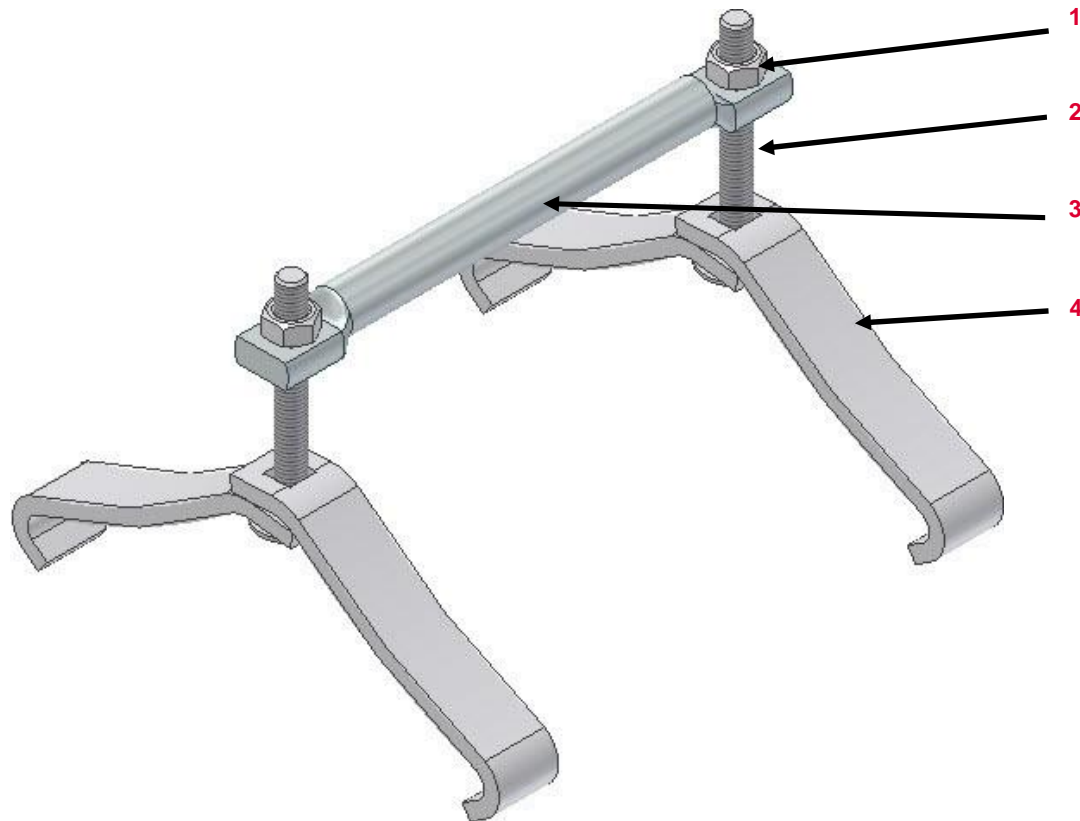

No.	Name 名稱	Article number 品項編號
-----	---------	---------------------

1	Nut 螺母	024090
2	Bolt 螺栓	
3	Horizontal bracket 水平支架	726041
4	Hook HB HB 鉤子	024040





















Valid for 適用產品

	Article number 品項編號
Hook Strap HB	024110
Cross Strap HB	024860
Double Hook Strap DHB	024170

PERI Rental Criteria 租賃準則

VARIO Accessories



Hook Strap HB, 吊鉤帶 HB	描述	說明	收費說明	類型
	09.15 Bolts Nuts Hooks 螺栓 螺母 鉤子	<ul style="list-style-type: none"> ■ Missing 遺失  		
	<ul style="list-style-type: none"> ■ Or damaged through force 或受外力破壞 			
	<ul style="list-style-type: none"> ■ Or soiled 或污損 			
	09.16 Horizontal bracket 水平支架	<ul style="list-style-type: none"> ■ Missing 遺失  		
	<ul style="list-style-type: none"> ■ Or damaged through force 或受外力破壞 			
	<ul style="list-style-type: none"> ■ Or soiled 或污損 			

PERI Rental Criteria 租賃準則

VARIO Accessories



Hook Strap for T20, T20 吊鉤帶 (024880)

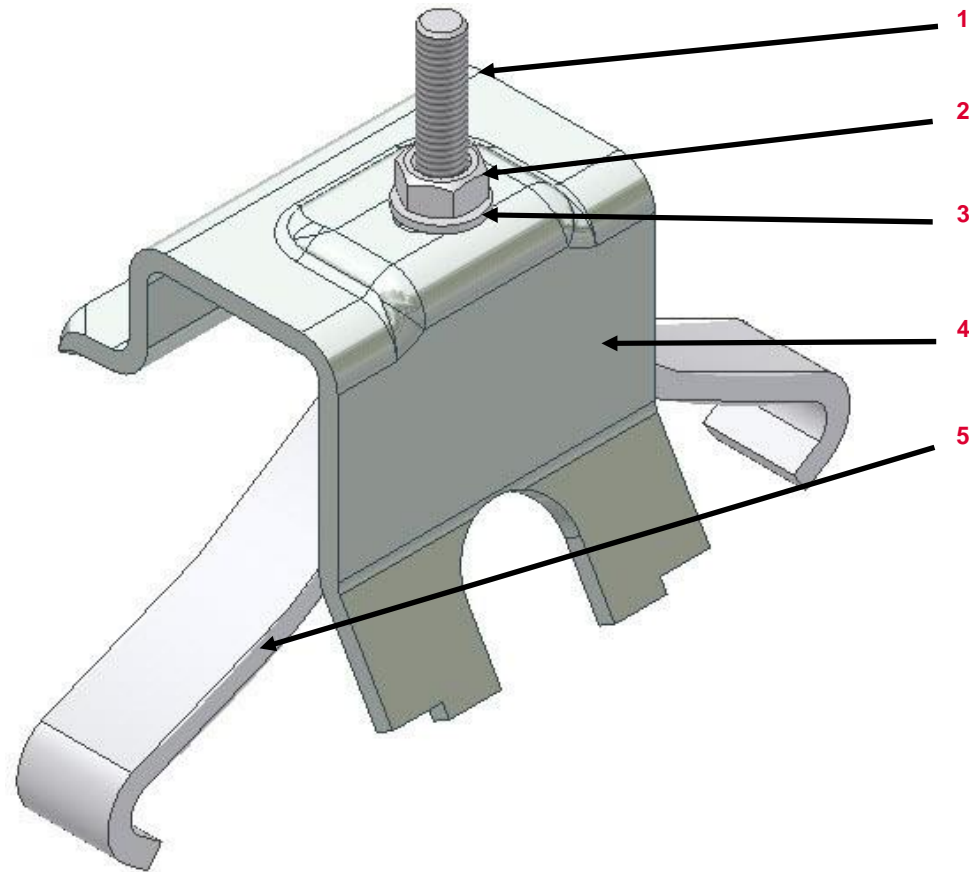

No.	Name 名稱	Article number 品項編號
1	Bolt 螺栓	126228
2	Nut 螺母	024090
3	Washer 墊圈	780354
4	Brücke 連接板	721833
5	Hook 鉤子	024040

PERI Rental Criteria 租賃準則



VARIO Accessories

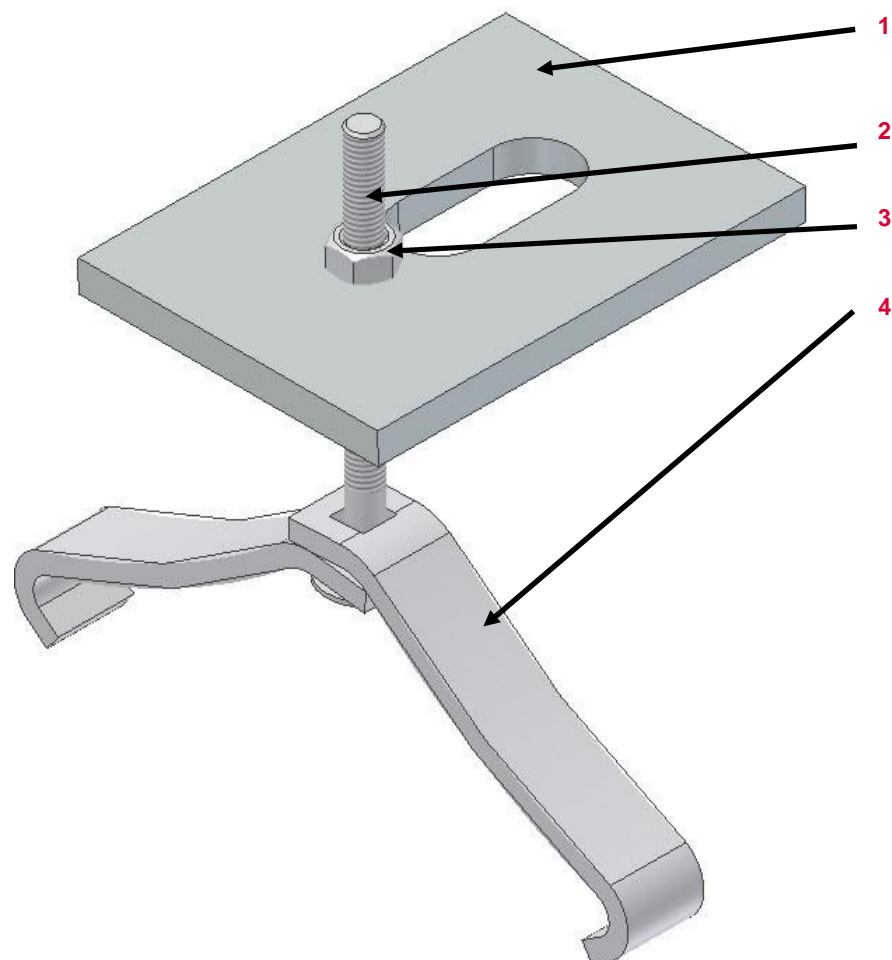

Fix Strap for U100-120, U100-120 固定帶 (024630)



No.	Name 名稱	Article number 品項編號
1	Pressure plate 壓力板	722670
2	Bolt 螺栓	710249
3	Nut 螺母	024090
4	Hook 鉤子	024040

T20 吊鉤帶 (024880) 固定帶 (024630)	描述	說明	收費說明	類型
	09.17 Bolt Nut Washer 螺栓 螺母 墊圈			
	<ul style="list-style-type: none"> Missing 遺失 			
	<ul style="list-style-type: none"> Or damaged through force 或受外力破壞 			
	09.18 Hook 鉤子			
	<ul style="list-style-type: none"> Missing 遺失 			
	<ul style="list-style-type: none"> Or damaged through force 或受外力破壞 			
	<ul style="list-style-type: none"> Or soiled 或污損 			

T20 吊鉤帶 (024880) 固定帶 (024630)	描述	說明	收費說明	類型
-------------------------------	----	----	------	----

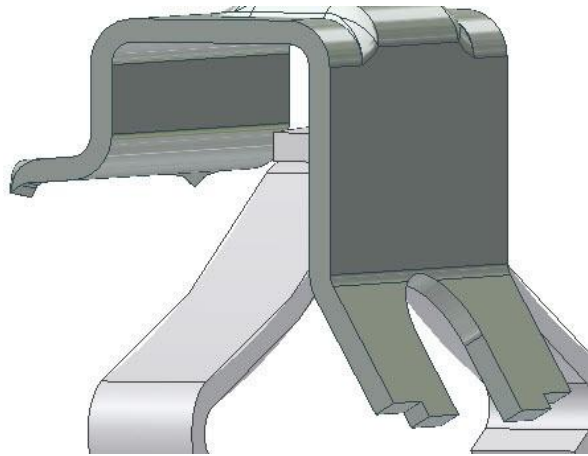

09.19 „Brücke“ bent
連接板彎曲

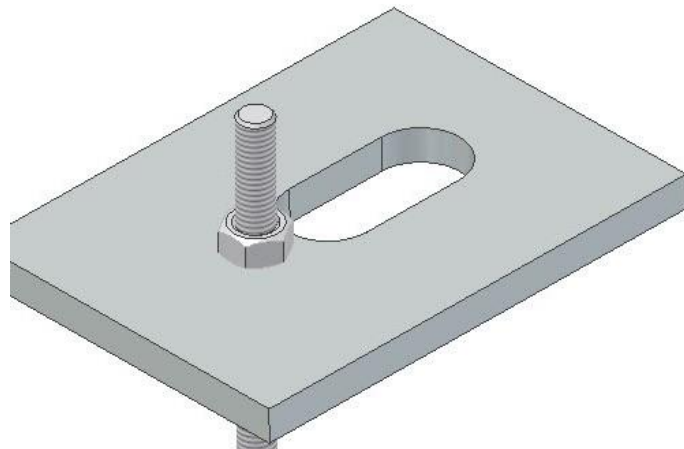

09.20 Pressure plate 壓力板

■ Bent 彎曲



■ Or Missing 或遺失



PERI Rental Criteria 租賃準則

VARIO Accessories







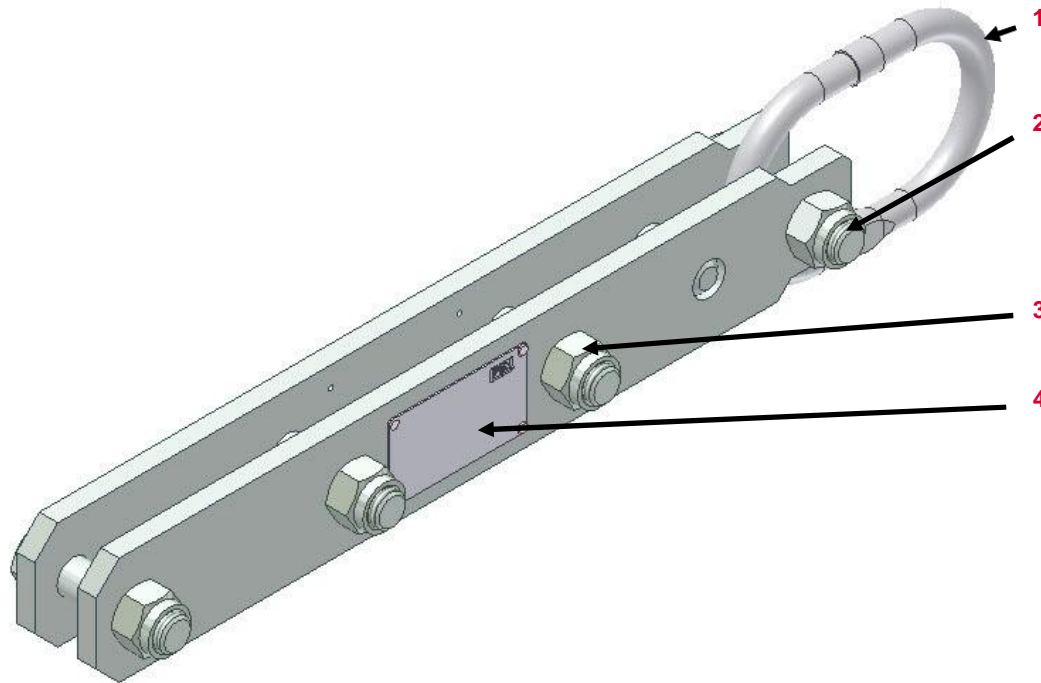









Crane Hook-2 VT20, 木樑 VT20 吊鉤-2 (113712)

No. Name 名稱 Article number 品項編號



1	Suspension Link 減震連接環	106894
2	Bolt 螺栓	024900
3	Nut 螺母	781053
4	Type plate 規格板	113721

Crane Hook-2 VT20, 木樑 VT20 吊鉤-2 (113712)	描述	說明	收費說明	類型
	<p>09.21 Bent 彎曲</p> <ul style="list-style-type: none"> ■ Within the tolerance 在容許範圍內 ■ Or out of tolerance and repairable 或超出容許範圍但可修復 ■ Or out of tolerance and not repairable 或超出容許範圍且無法修復 	<ul style="list-style-type: none">    	<ul style="list-style-type: none">    	<ul style="list-style-type: none">   
	<p>09.22 Bolts Nuts 螺栓 螺母</p> <ul style="list-style-type: none"> ■ Missing 遺失 ■ Or damaged through force 或受外力破壞 	<ul style="list-style-type: none">   	<ul style="list-style-type: none">   	<ul style="list-style-type: none">  

Crane Hook-2 VT20, 木樑 VT20 吊鉤-2 (113712) 描述	說明	收費說明	類型
---	----	------	----

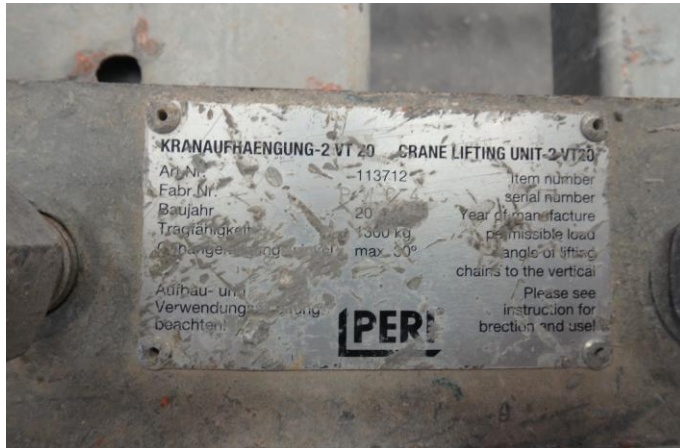

09.23 Type plate 規格板

- Missing 遺失



- Or not readable 或無法辨讀

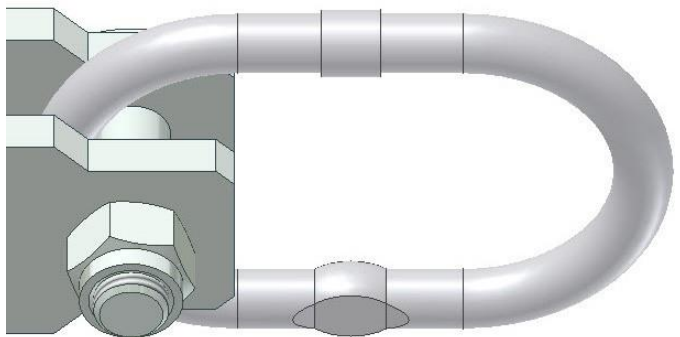

09.24 Suspension Link 減震連接環

- Worn 磨損 ($\varnothing < 9$ mm)



- Or Missing 或遺失



PERI Rental Criteria 租賃準則

VARIO Accessories



Tie Yoke Head SRU, 背撐頭 SRU(110756)

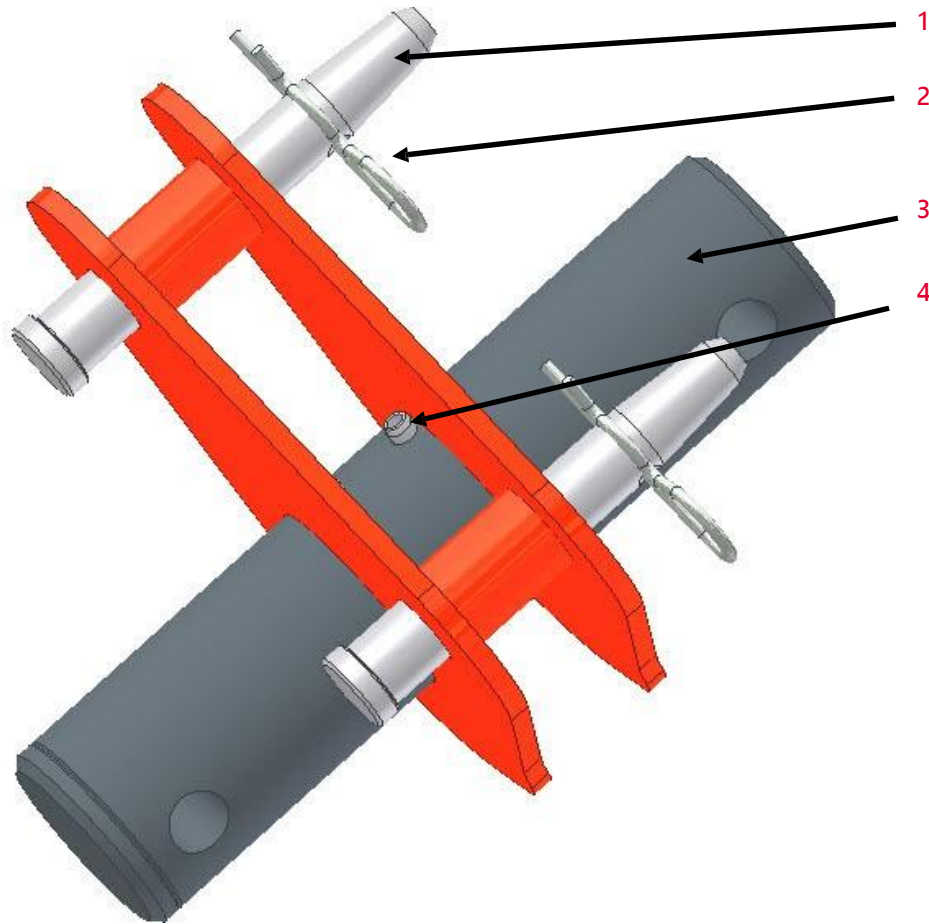

No.	Name 名稱	Article number 品項編號
1	Pin 插銷	105400
2	Cotter pin 開口銷	018060
3	Tie Yoke 背撐管	131352
4	Dowel pin 定位銷	770013

PERI Rental Criteria 租賃準則

VARIO Accessories















Tie Yoke Head SRU, 背撐頭 SRU (110756)	描述	說明	收費說明	類型	
	09.25 Pin Cotter pin Dowel pin Tie yoke 固定銷 開口銷 定位銷 背撐管	<ul style="list-style-type: none"> Missing 遺失 	 105400 (Pin) 018060 (Spring pin)		
	<ul style="list-style-type: none"> Or damaged through force 或受外力破壞 	 105400 (Pin) 018060 (Spring pin)			
	09.26 Bent 彎曲	<ul style="list-style-type: none"> If possible 如可以修復 			
	<ul style="list-style-type: none"> Or if not possible 如無法修復 				

PERI Rental Criteria 租賃準則

VARIO Accessories



Handrail Holder GT24/VT20, 扶手支架 (101290)	描述	說明	收費說明	類型	
	09.27 Bolt Cotter Pin 螺栓 開口銷	<ul style="list-style-type: none"> Missing 遺失 	 105400 (Bolt) 018060 (Cotter Pin)		
	<ul style="list-style-type: none"> Or damaged through force 或受外力破壞 	 105400 (Bolt) 018060 (Cotter Pin)			
	09.28 Bent 彎曲	<ul style="list-style-type: none"> If possible 如可以修復 			
	<ul style="list-style-type: none"> Or if not possible 如無法修復 				

PERI Rental Criteria 租賃準則

VARIO Accessories



Coupling Compression Plate KDP (024220) 壓力連接板 KDP

描述

說明

收費說明

類型

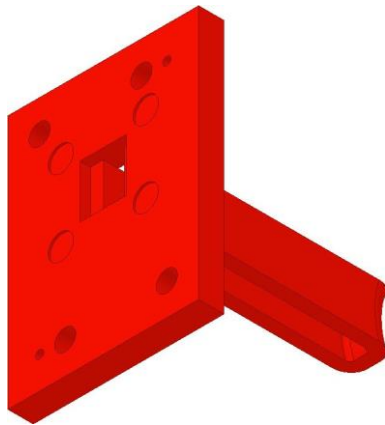

09.29 Bent 彎曲









Extension Splice 24, 延伸件 24 (024480)	描述	說明	收費說明	類型		
	09.30 Bent 彎曲	<ul style="list-style-type: none"> ■ If possible 如可以修復 				
	<ul style="list-style-type: none"> ■ Or if not possible 如無法修復 					
	09.31 Three wingnut 三聯螺母	<ul style="list-style-type: none"> ■ Missing 遺失 		030190 (Three wingnut)		
	<ul style="list-style-type: none"> ■ Or damaged through force 或受外力破壞 		030190 (Three wingnut)			











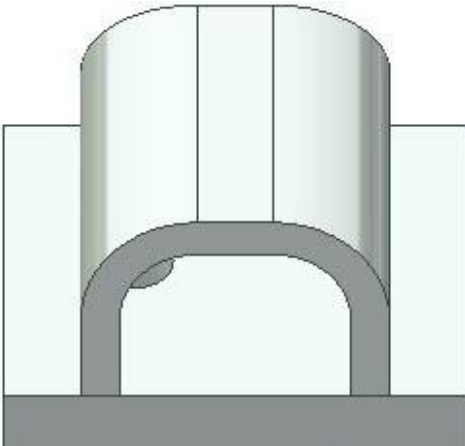

PERI Rental Criteria 租賃準則



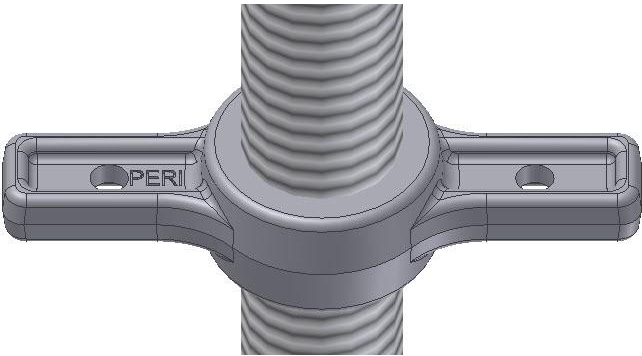







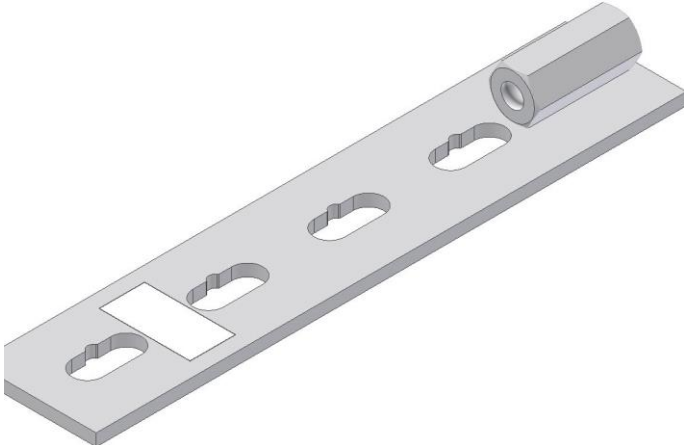

VARIO Accessories

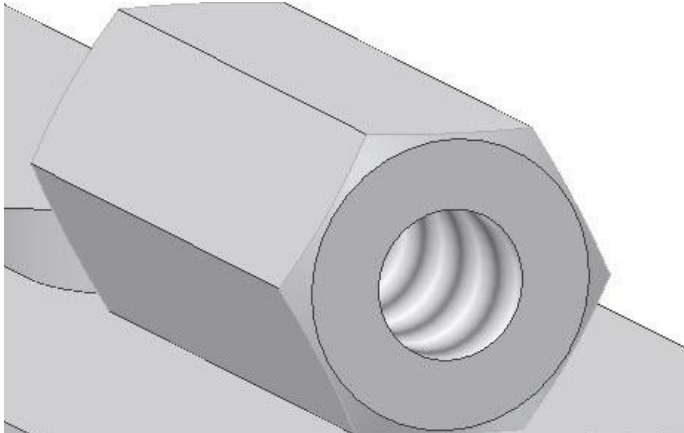

Girder Claw HB, 木樑夾 HB (024600)	描述	說明	收費說明	類型	
	<p>09.32 Bolt Nut Hook 螺栓 螺母 鉤子</p>	<ul style="list-style-type: none"> ■ Missing 遺失 ■ Or damaged through force 或受外力破壞 	<p>  710249 (Bolt)  024090 (Nut)  024040 (Hook) </p> <p>  710249 (Bolt)  024090 (Nut)  024040 (Hook) </p>		
	<p>09.33 Edge Girder Connector Bent 夾具邊緣彎曲</p>	<p>  710968 (Edge Girder Connector) </p>			

Handrail Holder SRU, 扶手支架 SRU (104131)	描述	說明	收費說明	類型	
	09.34 Tube bent 管子彎曲	<ul style="list-style-type: none"> ■ If possible 如可以修復 			
	<ul style="list-style-type: none"> ■ Or if not possible 如無法修復 				
	09.35 Pin Cotter pin 固定銷 開口銷	<ul style="list-style-type: none"> ■ Missing 遺失 	 105400 (pin) 018060 (cotter pin)		
	<ul style="list-style-type: none"> ■ Or damaged through force 或受外力破壞 	 105400 (pin) 018060 (cotter pin)			

Spindle Head SRU, SRU 調整頭 (109630)	描述	說明	收費說明	類型	
	09.36 Head bent 叉頭彎曲	<ul style="list-style-type: none"> ■ If possible 如可以修復 			
	<ul style="list-style-type: none"> ■ Or if not possible 如無法修復 				
	09.37 Cam nut 凸輪螺母	<ul style="list-style-type: none"> ■ Missing 遺失 			
	<ul style="list-style-type: none"> ■ Or damaged through force 或受外力破壞 				

Bulkhead Tie, 隔板螺桿 (013240)	描述	說明	收費說明	類型	
	09.38 Bent 彎曲	<ul style="list-style-type: none"> ■ If possible 如可以修復 			
	<ul style="list-style-type: none"> ■ Or if not possible 如無法修復 				
	09.39 Thread not moveable 螺紋無法移動	<ul style="list-style-type: none"> ■ Worn 磨損 			
	<ul style="list-style-type: none"> ■ Or damaged through force 或受外力破壞 				











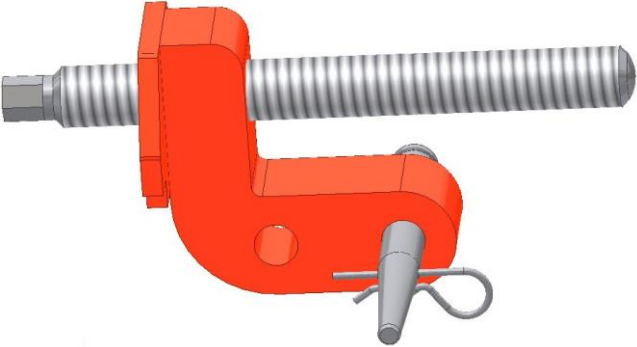

PERI Rental Criteria 租賃準則

VARIO Accessories

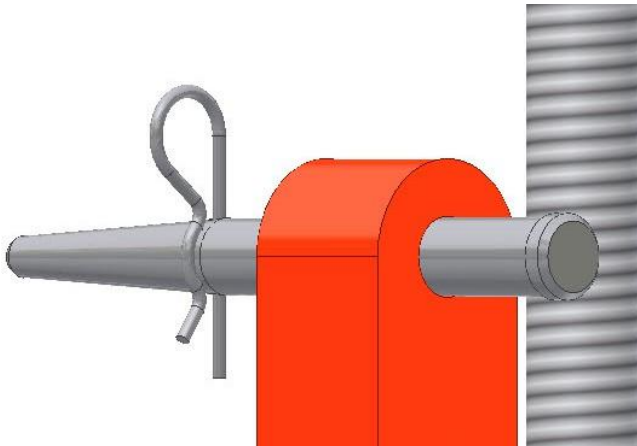

Lowering Wedge, 降座 (024590; 117930)	描述	說明	收費說明	類型	
	<p>09.40 Function not available 功能無法正常使用</p>	<ul style="list-style-type: none"> ■ Worn 磨損 			
	<ul style="list-style-type: none"> ■ Or damaged through force 或受外力破壞 				
	<p>09.41 Bent 彎曲</p>	<ul style="list-style-type: none"> ■ If possible 如可以修復 			
	<ul style="list-style-type: none"> ■ Or if not possible 如無法修復 				

















Errection Bar, 安裝叉 (070740)	描述	說明	收費說明	類型	
	09.42 Bar bent 桿件彎曲	<ul style="list-style-type: none"> ■ If possible 如可以修復 			
	<ul style="list-style-type: none"> ■ Or if not possible 如無法修復 				
	09.43 Complete Errection bar bent 整支安裝叉彎曲	<ul style="list-style-type: none"> ■ If possible 如可以修復 			
	<ul style="list-style-type: none"> ■ Or if not possible 如無法修復 				

Adjusting Unit SRU, 調整元件 SRU (111135)	描述	說明	收費說明	類型	
	09.44 Spindle 叉	<ul style="list-style-type: none"> Worn 磨損 	 111132 (Spindle)		
	<ul style="list-style-type: none"> Or damaged through force 或受外力破壞 	 111132 (Spindle)			
	09.45 Pin Cotter pin 開口銷 固定銷	<ul style="list-style-type: none"> Missing 遺失 	 104031 (Pin) 018060 (Cotter pin)		
	<ul style="list-style-type: none"> Or damaged through force 或受外力破壞 	 104031 (Pin) 018060 (Cotter pin)			

PERI Rental Criteria 租賃準則

Glossary Icons 圖示對照表



圖示	含意	圖示	含意	圖示	含意
	Not OK – Scrap 材料需報廢		Compensation (customer) 客戶需賠償		Optical damage – it's permitted to handle out 可見的損壞 · 可以被修復或處理
	OK— Article stays in Rental Park 材料仍在可租賃使用的範圍		No compensation 無需賠償		Functional damage – it's permitted to handle out 功能損壞 · 可以被修復或處理
	It's not permitted to handle out the article because of security aspects 因安全考量無法再交付 · 材料需報廢		Shorten the article 需裁短材料		Functional damage– it's not permitted to handle out 功能損壞 · 無法被修復或處理
	Repair according to Working Instruction 材料需依指示修復		Mark article 需在材料上標記		Statical damage– it's not permitted to handle out 物理損壞 · 無法再使用
	Fix article cold 材料需修復		Replace defect components 需替換損壞零件		
	Repair after local profitability calculation 需在計算當地利潤後修復		Replace missing components 需替換遺失零件		
	Clean the article 材料需清潔				

PERI Rental Criteria 租賃準則

VT 20 Girder

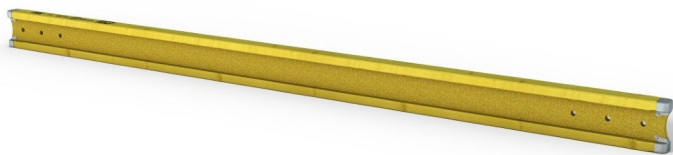

派利台灣有限公司
 台北市信義區基隆路一段163號
 10樓之一
 電話：02-3765-1211
 傳真：02-3765-1221
info@peri.tw

內容	頁數	修訂	日期 初始版本	頁數
Chord 翼板	4	New version 新版本	07/2015 lcg	
Web 腹板	13	02.05 Change of Billing Condition 收費條件修改	06/2016 fw	6
End cap 金屬頭	18	02.29 New criteria added 加入新準則	03/2026 PT	19
Glossary 圖示對照表	19			

PERI Rental Criteria 租賃準則

VT 20 Girder



VT 20 Girder	No.	Name 名稱	Article number 品項編號
--------------	-----	---------	---------------------

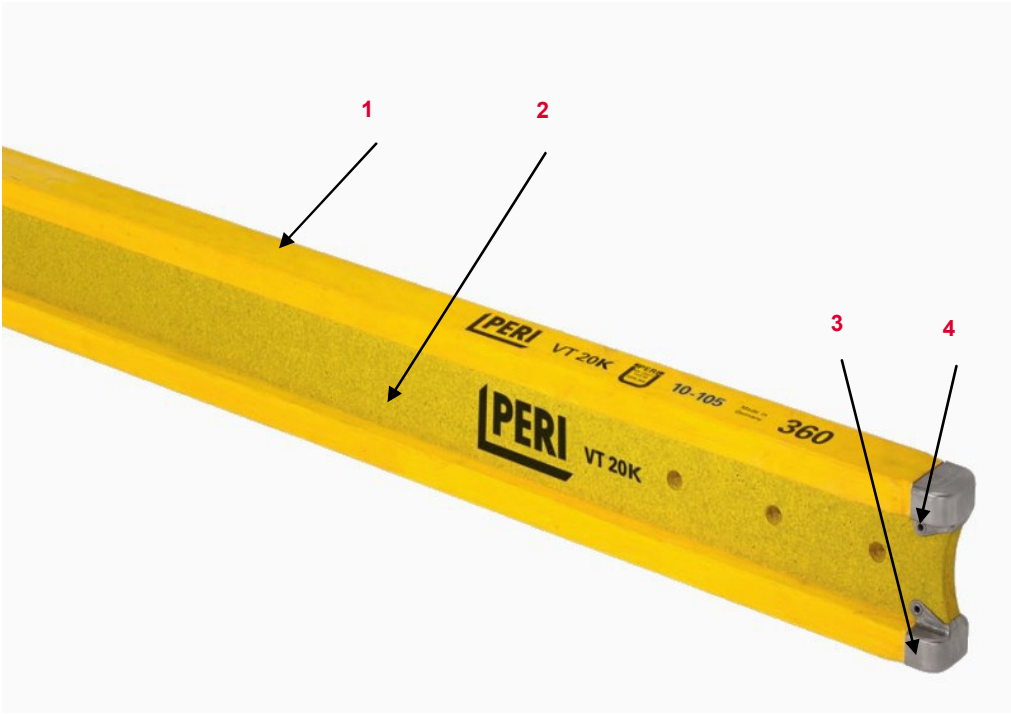

1	Chord 翼板	
2	Web 腹板	
3	End cap 金屬頭	116162
4	Rivet 鉚釘	116119

PERI Rental Criteria 租賃準則

VT 20 Girder











Article 品項	Article number 品項編號
Girder VT 20K L = 1,45 m	074990
Girder VT 20K L = 2,15 m	074905
Girder VT 20K L = 2,45 m	074910
Girder VT 20K L = 2,65 m	074890
Girder VT 20K L = 2,90 m	074920
Girder VT 20K L = 3,30 m	074930
Girder VT 20K L = 3,60 m	074940
Girder VT 20K L = 3,90 m	074950
Girder VT 20K L = 4,50 m	074960
Girder VT 20K L = 4,90 m	074970
Girder VT 20K L = 5,90 m	074980

Article 品項	Article number 品項編號
Girder VT 20 L = 1,45 m	073710
Girder VT 20 L = 2,15 m	073720
Girder VT 20 L = 2,45 m	073730
Girder VT 20 L = 2,65 m	073740
Girder VT 20 L = 2,90 m	073750
Girder VT 20 L = 3,30 m	073760
Girder VT 20 L = 3,60 m	073770
Girder VT 20 L = 3,90 m	073780
Girder VT 20 L = 4,50 m	073790
Girder VT 20 L = 4,90 m	073800
Girder VT 20 L = 5,90 m	073810

PERI Rental Criteria 租賃準則

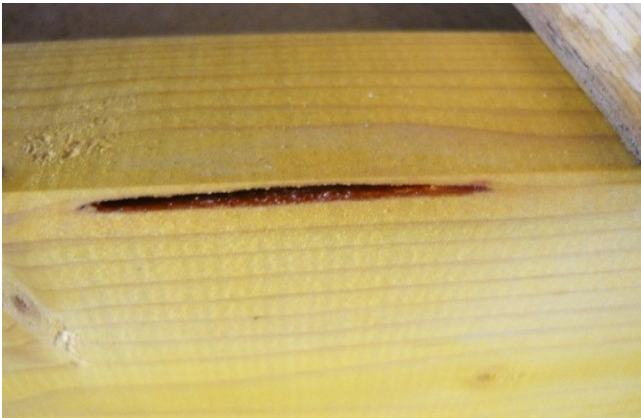
VT 20 Girder







Chord 翼板	描述	說明	收費說明	類型
	02.01 Intergrowth of bark 天然木紋			
	02.02 Resin inclusion 參雜樹脂 ■ ≤5 mm			

PERI Rental Criteria 租賃準則

VT 20 Girder











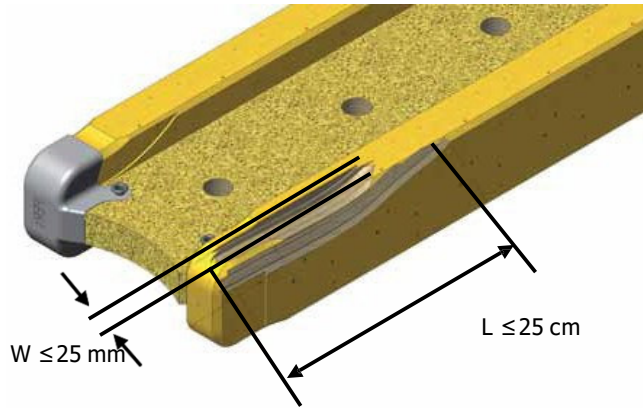





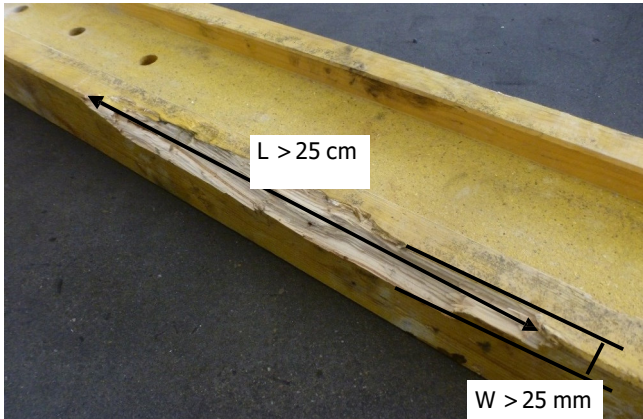

Chord 翼板	描述	說明	收費說明	類型
	<p>02.03 Knot in the girder edge 木樑邊緣有木結</p>			
	<p>02.04 Round break 圓形破損</p>	 		

PERI Rental Criteria 租賃準則

VT 20 Girder









Chord 翼板	描述	說明	收費說明	類型
	<p>02.05 Splintering at the Chord 翼板破損</p> <ul style="list-style-type: none"> Length 長度 ≤ 25 cm and width 且寬度 ≤ 25 mm <ul style="list-style-type: none"> Or length 或長度 > 25 cm and width 且寬度 ≤ 10 mm 	<ul style="list-style-type: none">    	<ul style="list-style-type: none">   	<ul style="list-style-type: none">  
	<p>02.06 Splintering at the Chord 翼板破損</p> <ul style="list-style-type: none"> Length 長度 > 25 cm and width 且寬度 > 10 mm <ul style="list-style-type: none"> Or width 或寬度 > 25 mm 	<ul style="list-style-type: none">     	<ul style="list-style-type: none">   	<ul style="list-style-type: none">  

PERI Rental Criteria 租賃準則

VT 20 Girder



Chord 翼板	描述	說明	收費說明	類型
	<p>02.07 Break in the Chord 翼板破裂</p>	 		
				

PERI Rental Criteria 租賃準則

VT 20 Girder



Chord 翼板	描述	說明	收費說明	類型
	<p>02.08 Shrinkage cracks because of drying out the timber 因木材乾燥而產生龜裂</p> <ul style="list-style-type: none"> Shrinkage crack along the grain 沿著木紋的龜裂 and no continuous crack 無連續裂痕 and max. length 1 m 最大長度1公尺 and max. width < 4 mm 最大寬度小於4公厘 			
	<p>02.09 Shrinkage crack 龜裂</p> <ul style="list-style-type: none"> Width > 4 mm 寬度 > 4公厘 Or length > 1 m 或長度 > 1公尺 	   	 	 

PERI Rental Criteria 租賃準則

VT 20 Girder



Chord 翼板	描述	說明	收費說明	類型
	<p>02.10 Cracks caused by mis- use 因錯誤使用造成的破裂</p> <ul style="list-style-type: none"> Occurrence in relation to a damage/ kink (deformed End cap , splinters, etc.) 與損壞/扭結相關的情況 (金屬頭變形、碎裂等) 	 		

PERI Rental Criteria 租賃準則

VT 20 Girder



Chord 翼板	描述	說明	收費說明	類型
	02.13 Cut into the Chord 切損翼板			
	<ul style="list-style-type: none"> ■ Cut ≤ 2 mm depth 切痕≤ 2公厘深 ■ Or cut > 2 mm depth 或切痕> 2公厘深 			
	02.14 Cut length in Chord 翼板上的切痕			
	<ul style="list-style-type: none"> ■ ≤ 3 mm depth ≤ 3公厘深 ■ and distance > 15 cm 相距 > 15公分 			
	<ul style="list-style-type: none"> ■ Or ≤ 3 mm depth 或≤ 3公厘深 ■ and distance < 15 cm 且相距 < 15公分 			
	<ul style="list-style-type: none"> ■ Or > 3 mm depth 或> 3公厘深 			

PERI Rental Criteria 租賃準則

VT 20 Girder



Chord 翼板	描述	說明	收費說明	類型
	<p>02.15 Girder cut not to PERI Standard 切割不符合 PERI 標準</p>			
	<p>02.16 Damage caused by concrete vibrator 因混凝土振動器造成的損壞</p> <ul style="list-style-type: none"> ■ Pressure marks $\leq 3,0$ mm 壓痕 $\leq 3,0$ 公厘 ■ Or pressure marks $> 3,0$ mm 或壓痕 $> 3,0$ 公厘 	 	 	 

PERI Rental Criteria 租賃準則

VT 20 Girder



Chord 翼板	描述	說明	收費說明	類型
	<p>02.17 Drill holes in Chord 在翼板上鑽孔</p> <ul style="list-style-type: none"> ■ $\leq \varnothing 8 \text{ mm}$ ■ and distance $> 15 \text{ cm}$ 且相距 > 15公分 ■ $\leq \varnothing 8 \text{ mm}$ ■ and distance $\leq 15 \text{ cm}$ 且相距 ≤ 15公分 ■ Or $> \varnothing 8 \text{ mm}$ 	<div style="display: flex; flex-direction: column; gap: 10px;"> <div style="display: flex; gap: 5px;"> </div> <div style="display: flex; gap: 5px;"> </div> <div style="display: flex; gap: 5px;"> </div> </div>	<div style="display: flex; flex-direction: column; gap: 10px;"> </div>	<div style="display: flex; flex-direction: column; gap: 10px;"> </div>

PERI Rental Criteria 租賃準則

VT 20 Girder



Web 腹板	描述	說明	收費說明	類型
	<p>02.18 Cut in the Web 腹板刻痕</p> <ul style="list-style-type: none"> Length > 20 mm 長度 > 20 公厘 			
	<p>02.19 Break of the Web 腹板破裂</p> <ul style="list-style-type: none"> Length > 20 mm 長度 > 20 公厘 			

PERI Rental Criteria 租賃準則

VT 20 Girder











Web 腹板	描述	說明	收費說明	類型
	<p>02.20 Splintering 碎裂</p> <ul style="list-style-type: none"> ■ Depth ≤ 20 mm 深度 ≤ 20公厘 ■ Or depth > 20 mm 或深度 > 20公厘 	<div style="display: flex; flex-direction: column; align-items: center;"> <div style="display: flex; gap: 5px;"> ✓ 🔪 </div> <div style="display: flex; gap: 5px; margin-top: 10px;"> 🗑️ 🚫 </div> </div>	<div style="display: flex; flex-direction: column; align-items: center;"> <div style="margin-bottom: 10px;"></div> <div></div> </div>	<div style="display: flex; flex-direction: column; align-items: center;"> <div style="margin-bottom: 10px;"></div> <div></div> </div>

PERI Rental Criteria 租賃準則

VT 20 Girder



Web 腹板	描述	說明	收費說明	類型
	<p>02.21 PERI standard drill holes PERI 標準材料鑽孔</p> <ul style="list-style-type: none"> ■ Ø 22 mm ■ and distance 140 mm 相距 140 公厘 			
	<p>02.22 Drill holes 鑽孔</p> <ul style="list-style-type: none"> ■ <Ø 20 ■ and more than one each meter 每公尺多於1個孔 	 		

PERI Rental Criteria 租賃準則

VT 20 Girder



Web 腹板	描述	說明	收費說明	類型
	<p>02.23 Drill holes 鑽孔</p> <ul style="list-style-type: none">■ > Ø 22 mm			

PERI Rental Criteria 租賃準則

VT 20 Girder













Web 腹板	描述	說明	收費說明	類型	
	<p>02.24 Chord separated from Web 翼板與腹板分離</p>				
	<p>02.25 Wood broken in the finger joint 木材破損__</p>				
	<p>02.26 Chord separated from Web 翼板與腹板分離</p>	<ul style="list-style-type: none"> ■ Damage caused by force 			

PERI Rental Criteria 租賃準則

VT 20 Girder



End cap 金屬頭	描述	說明	收費說明	類型
	<p>02.27 End cap damaged 金屬頭損壞</p> <ul style="list-style-type: none"> Destroyed 破壞 and splintering 破損 		 	
	<p>02.28 End cap damaged 金屬頭損壞</p> <ul style="list-style-type: none"> Bent 彎曲 Or crack in End cap 金屬頭破損 	  116162 116119	 	 

PERI Rental Criteria 租賃準則

VT 20 Girder



















外觀	描述	說明	收費說明	類型
	02.29 Any paint mark 任何油漆痕跡			

PERI Rental Criteria 租賃準則

Glossary Icons 圖示對照表



圖示	含意	圖示	含意	圖示	含意
	Not Ok– material is scrap 材料需報廢		Billing necessary (customer) 須收費		Optical damage 可見的損壞
	OK– material stays in rental park 材料仍在可租賃使用的範圍		No Billing necessary 無須收費		Functional damage 功能損壞
	Scrap material– it's not permitted to hand out the material because of safety aspects 因安全考量無法再交付，材料需報廢		Shorten the material 需裁短材料		Functional damage— it's not permitted to hand out the material 功能損壞 – 無法再使用
	Repair according to instruction 材料需依指示修復		Mark the material 需在材料上標記		Static damage— it's not permitted to hand out the material 物理損壞 – 無法再使用
	Fix material cold—Afterwards check weld seams and bordering components 修復材料——之後檢查焊縫和邊界組件		Replace damaged material 需替換損壞材料		
	Clean the material 材料須清理		Replace missing material 需替換遺失材料		